

MANUAL DE INSTRUÇÕES

RECOMENDAÇÕES

Uso interno. Não expor ao sol ou umidade.

Não exceder a capacidade de peso.

MANUTENÇÃO E LIMPEZA

Limpar com pano macio umedecido em solução de água e sabão neutro e secar em seguida.

Não utilizar produtos químicos ou abrasivos.

MANUAL DE INSTRUÇÕES

BANQUETA BASE MADEIRA

Théus

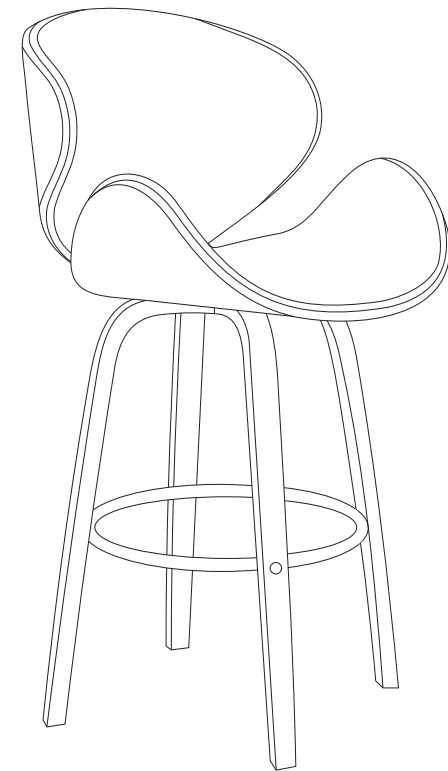

COMPONENTES

1 UNID.

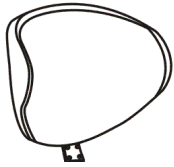

①

1 UNID.



②

4 UNID.



③

1 UNID.



④

1 UNID.



⑤

1 UNID.

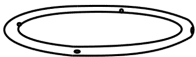

⑥

8 UNID - 25mm



⑦

4 UNID - 35mm



⑧

4 UNID - 16mm



⑨

4 UNID. - 20mm



⑩

4 UNID.



⑪

4 UNID.



⑫

1 UNID.



⑬

INSTRUÇÕES DE MONTAGEM

1. Certifique-se que possui todos os componentes listados;
2. Siga as figuras para a montagem do produto.

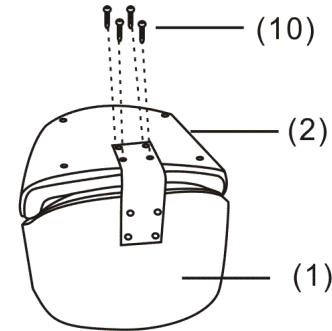

1

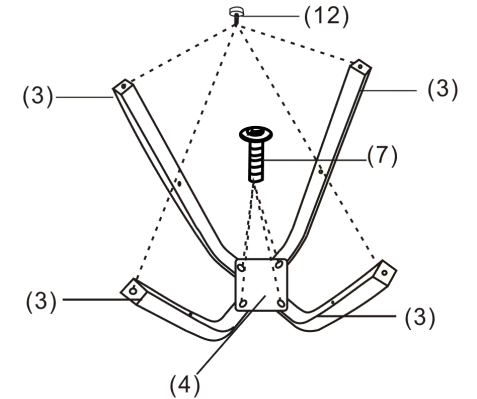

2

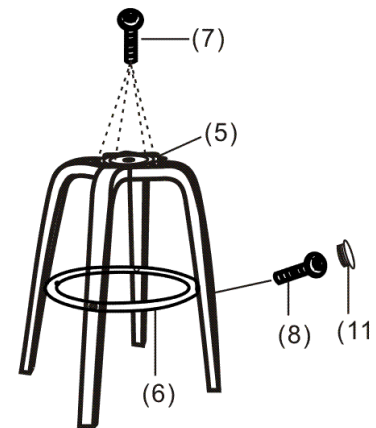

3

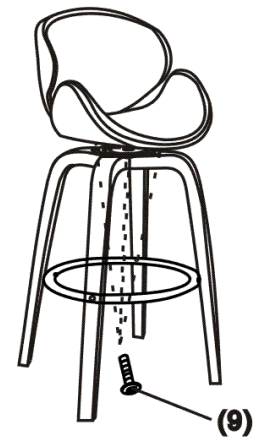

4

